

KM 604 HPXdrive

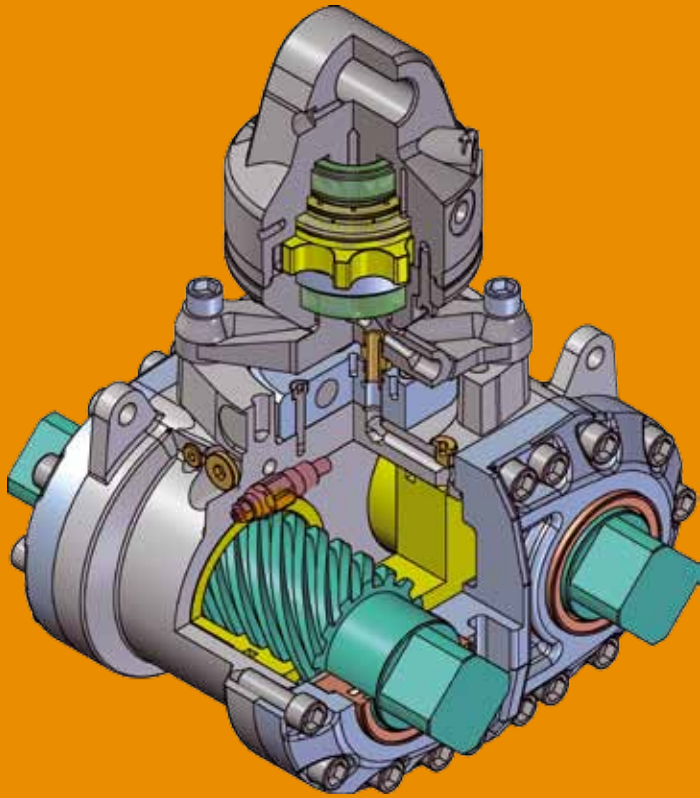

HPXdrive®

www.kinshofer.com



KINSHOFER

crane and excavator attachments

KM 604HPXdrive

The KM 604 *HPXdrive* as an allround unit is perfect for the daily routine jobs with a constant closing force of 19 kN.

Technical specifications:

| | |
|----------------------------|---------------------------------------|
| Closing force (of 26 MPa): | 19 kN for the KM 604HPX |
| Torque (at 26 MPa): | 12000 Nm |
| Operating pressure: | 26 to 32 MPa (approx. 260 to 320 bar) |
| Recommended oil flow: | 25 to 75 l/min |

Historically the open and close functions of the attachments were achieved by using hydraulic cylinders, now they are generated by two hollow shafts, which run opposed and have a helix thread, hydraulically driven by a single piston. Through the advantages of the *HPXdrive* – technology time is saved and the service life is extended.

Constant Closing Force

Full closing force is delivered from the beginning of the digging process, when the shells are in the opened position, ensuring powerful penetration even in grown soil. Full closing force is also provided at the end when the shells are closed, to optimally compact the material.

Please note: Closing forces refer to an internal working pressure of 26 MPa (260 bar). The recommended oil flow of 50 l/min provides an opening and closing time of 1,9 sec.

Comparison of Closing Forces

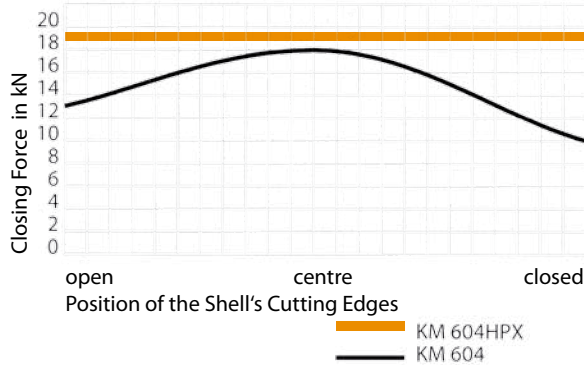

Compact Design

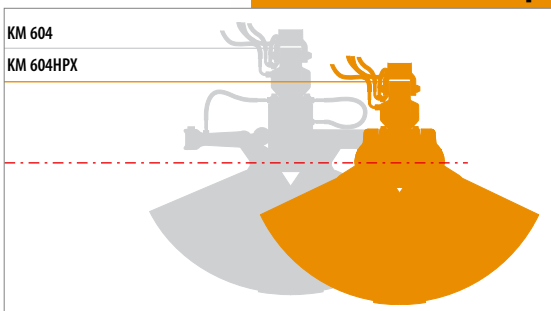

HPXdrive - the compact unit is resistant against dirt, blows and uprising material. Low overall height due to the compact design. No protruding parts. Shells are easily accessible from the top. No hoses are required in combination with a **KINSHOFER**-rotator with flange: **KINSHOFER**-rotator and *HPXdrive* are integrated in a single unit (internal oil passage).

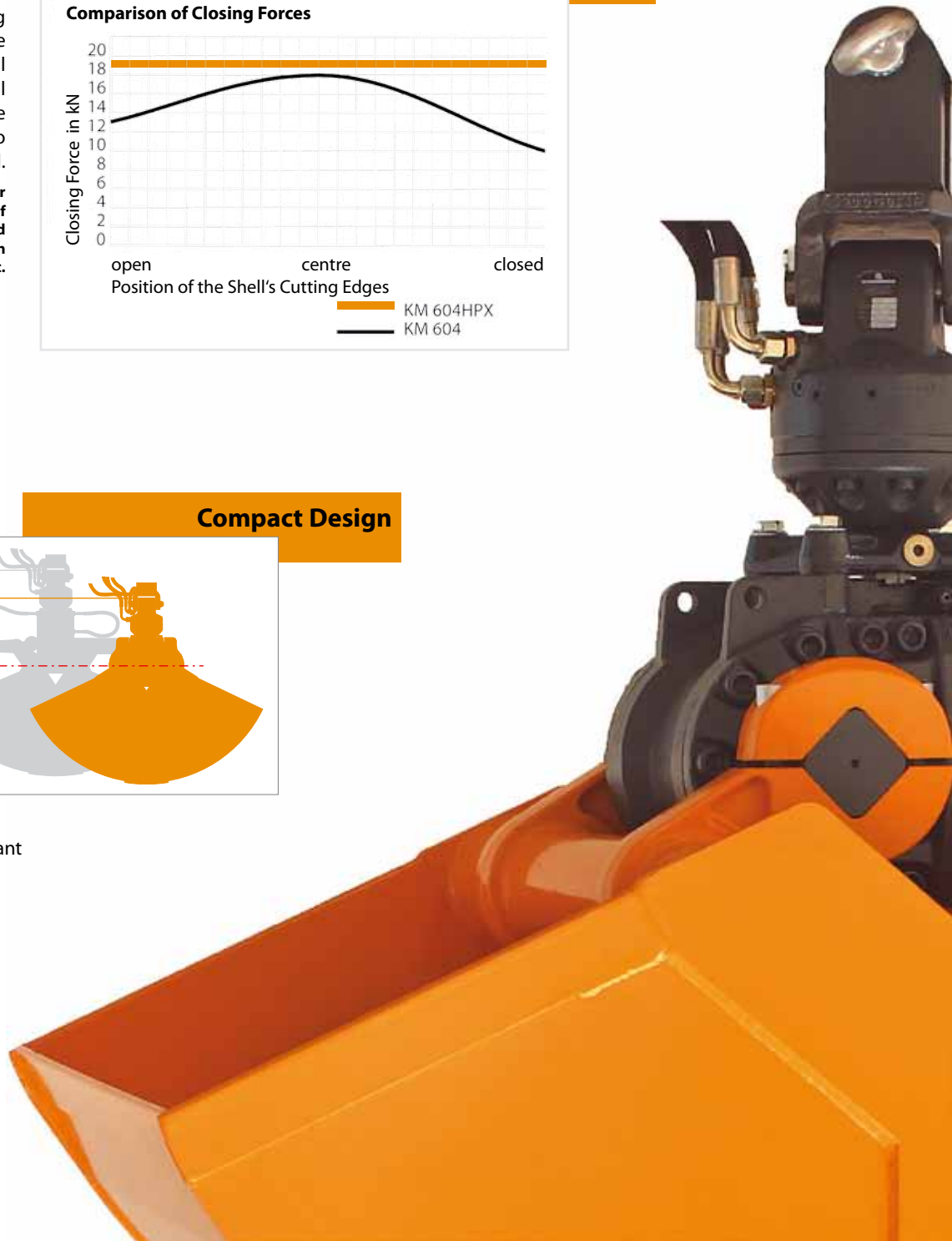

Combination with shaft-style rotator

KM 501
Upper suspension



The standard rotator for the KM 604 **HPXdrive** is the **KINSHOFER** rotator with flange KM 04F140-30V. In case a quick change to a non rotating hook is necessary, the **HPXdrive** can be delivered with the **KINSHOFER** rotator with shaft KM 04 S – in combination with the quick change system KM 505 or reduction link KM 502.

KM 04 S
Rotator with shaft



KM 04 F
Rotator with flange



KM 505
Quick change system



KM 502
Reduction link



KM 460 04
Non-rotating hook



Easy exchange system



The bucket shells are bolted to the shafts, and therefore it is very easy to replace them with another set of shells. Different types of shells for different applications can be refitted onto the driving unit, e.g. clamshell bucket, rock grapple, timber grapple, hay and forestry grapple and multi-purpose clamshell.

KINSHOFER

Exchangeable shells for the *HPXdrive Standard*

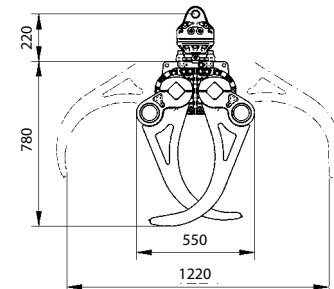
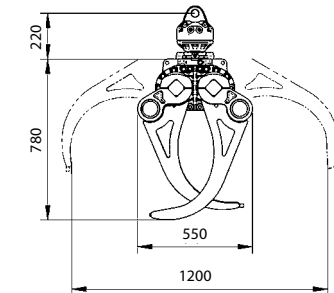
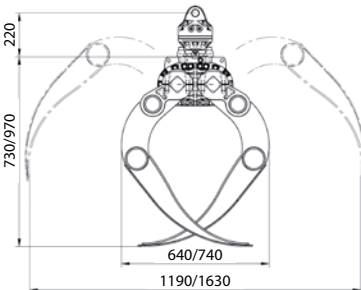
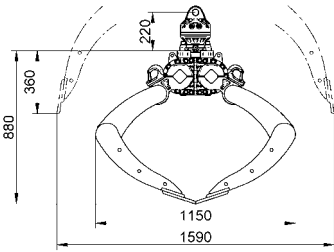
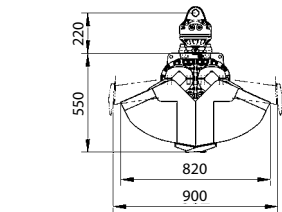
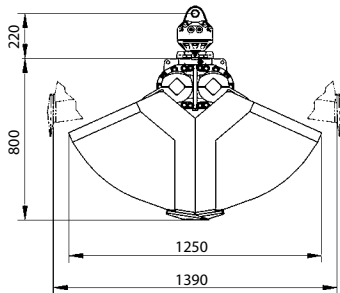

| Type | Capacity (litre) | Width (mm) | Number of teeth required | Weight (kg) | Closing force (kN) | Load capacity (kg) |
|------|---------------------|---------------|--------------------------------|----------------|--------------------------|--------------------------|
|------|---------------------|---------------|--------------------------------|----------------|--------------------------|--------------------------|

Clamshell bucket - KM 604HPX

| | | | | | | |
|----------------------|-----|-----|---|-----|----|------|
| KM 604HPX-200 | 200 | 400 | 4 | 230 | 19 | 3000 |
| KM 604HPX-250 | 250 | 500 | 4 | 240 | 19 | 3000 |
| KM 604HPX-325 | 325 | 600 | 6 | 265 | 19 | 3000 |
| KM 604HPX-350 | 350 | 650 | 6 | 275 | 19 | 3000 |
| KM 604HPX-450 | 450 | 800 | 6 | 290 | 19 | 3000 |

Clamshell bucket with smaller volume - KM 626HPX

| | | | | | | |
|----------------------|-----|-----|---|-----|----|------|
| KM 626HPX-95 | 95 | 400 | 4 | 180 | 31 | 2000 |
| KM 626HPX-100 | 100 | 450 | 4 | 190 | 31 | 2000 |
| KM 626HPX-150 | 150 | 600 | 6 | 220 | 31 | 2000 |

Multi-purpose clamshell - KM 604U HPX

| | | | | | | |
|------------------------|-----|-----|---|-----|----|------|
| KM 604U HPX-250 | 250 | 570 | - | 320 | 17 | 3000 |
| KM 604U HPX-300 | 300 | 670 | - | 335 | 17 | 3000 |
| KM 604U HPX-400 | 400 | 820 | - | 355 | 17 | 3000 |

Hay and forestry grapple - KM 641HPX

| | | | | | | |
|----------------------|---------------------|-----|---|-----|----|------|
| KM 641HPX-0,2 | 0,20 m ² | 670 | 7 | 225 | 18 | 1000 |
| KM 641HPX-0,4 | 0,40 m ² | 940 | 7 | 300 | 14 | 2000 |

(Dimensions: KM 641HPX-0,2 / KM 641HPX-0,4)

Rock grapple - KM 613HPX

| | | | | | | |
|-----------------------|---------------------|-----|---|-----|----|------|
| KM 613HPX-0,16 | 0,16 m ² | 400 | - | 210 | 18 | 1000 |
|-----------------------|---------------------|-----|---|-----|----|------|

Timber grapple - KM 632HPX

| | | | | | | |
|------------------|---------------------|-----|---|-----|----|------|
| KM 632HPX | 0,16 m ² | 400 | - | 210 | 18 | 1000 |
|------------------|---------------------|-----|---|-----|----|------|

Package consists of: grapple, bolt-on teeth (KM 604HPX, KM 626HPX), rotator KM 04 F140-30V, upper suspension KM 501, pressure relief valves, non-return valve

Hauptsitz Deutschland:
KINSHOFER GmbH
 Hauptstrasse 76
 83666 Waakirchen
 Tel.: +49 (0)8021 – 88 99 0
 Fax: +49 (0)8021 – 88 99 37
 Email: info@kinshofer.com

United Kingdom:
KINSHOFER UK Ltd.
 4 Milton Industrial Court
 Horsfield Way, Bredbury
 Stockport, Cheshire, SK6 2TA
 Tel.: +44 (0)161 – 406 7046
 Fax: +44 (0)161 – 406 7014
 Email: sales@kinshofer.co.uk

France:
KINSHOFER France S.A.R.L.
 B.P. 20100
 67213 Obernai Cedex
 Tel.: +33(0) 3 88 39 55 00
 Fax: +33(0) 3 88 79 06 75
 Email: info@kinshofer.fr

Česká Republika a Slovinsko:
KINSHOFER CZ s.r.o.
 Cs. Legií 568
 37810 Ceske Velenice
 Tel.: +420 384 – 795 110
 Fax: +420 384 – 795 120
 Email: v.blazek@kinshofer.com

North America:
KINSHOFER North America
 5040 Mainway Drive, Unit #11
 Burlington, ON L7L 7G5
 Tel.: +1 (905) 335 2856
 Fax: +1 (905) 335 4529
 Toll Free (North America):
 +1 (800) 268 9525
 Email: sales-northamerica@kinshofer.com

Zhong Guo:
KINSHOFER Construction
 Machinery Co. Ltd.
 Unit #306, Landmark Tower 2
 8 Dongsanhuan Road
 Beijing 100004
 Tel.: +86 (10) 6590 6422
 Fax: +86 (10) 6590 6423
 Email: info@darda.com.cn
 Website: www.darda.com.cn

Suomi:
KINSHOFER
APONOX Oy
 Tölkimäentie 8
 FI-13130 Hämeenlinna
 Tel.: +358 (0)75 7540 200
 Fax: +358 (0)75 7540 210
 Email: info@kinshofer-aponox.com

Generalvertretung Benelux:
 Rigter Handelsonderneming
 Nieuwe Maatsweg 7
 NL-3755 NP Eemnes Nederland
 Tel.: +31 (0) 35 53 10628
 Fax: +31 (0) 35 53 17462
 Mobil: +31 (0) 653 - 370935
 +31 (0) 651 - 366420
 Email: gf.rigter@gmail.com
 kees.rigter@gmail.com

HPX604-KIN-E-0410-op

Up front, everywhere

KINSHOFER
 crane and excavator attachments